

DRAWINGS ARE FOR TENDER PURPOSES ONLY

Rev	dd/mm/yyyy	Description	Rev by	dd/mm/yyyy

Designed : IPEG
 Checked : 
 Approved : 

Client
SHILLONG SMART CITY LIMITED

Submitted By

 Expanding Horizons. Enriching Lives.

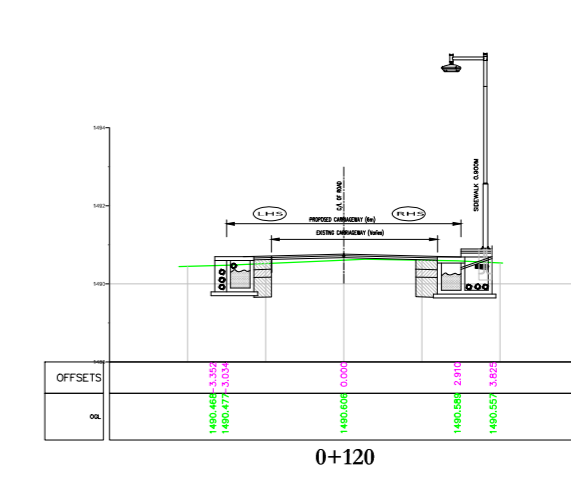
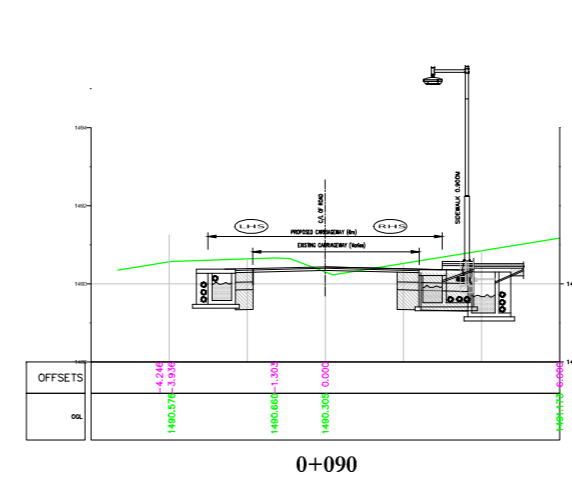
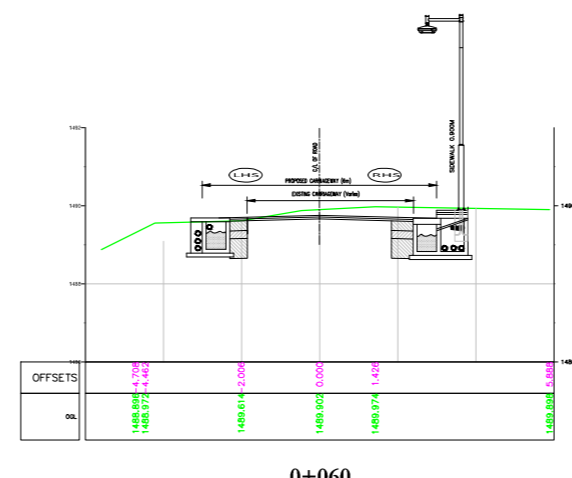
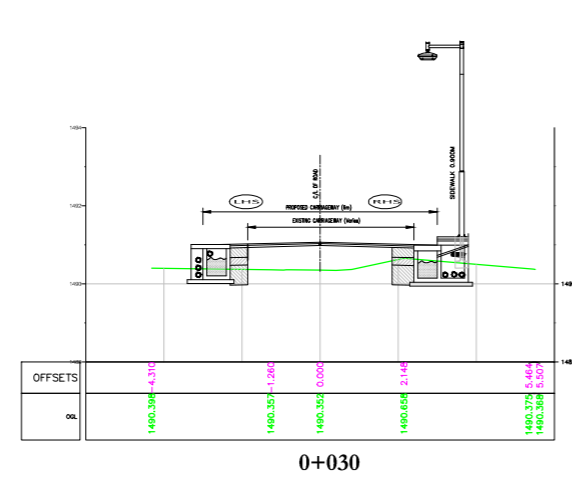
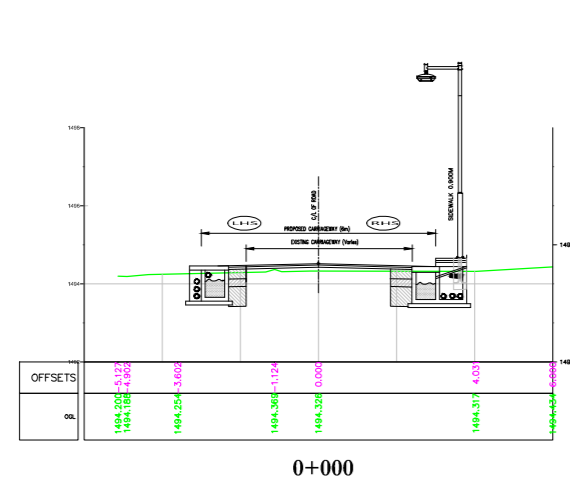
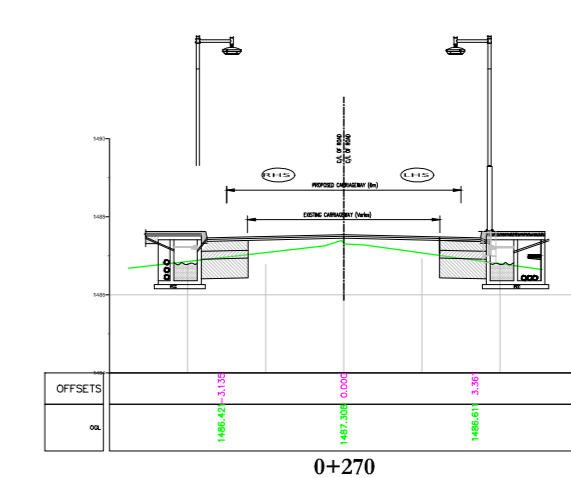
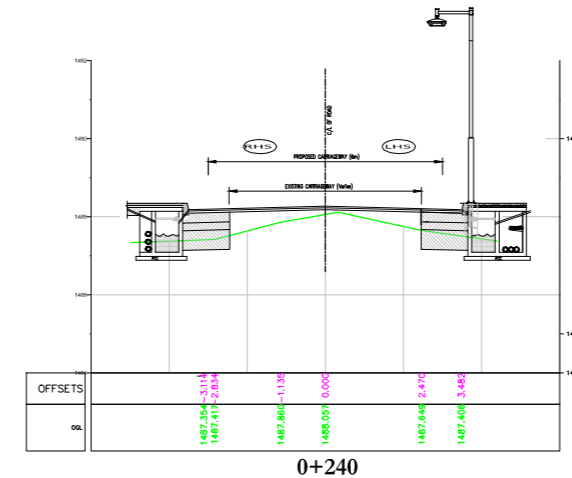
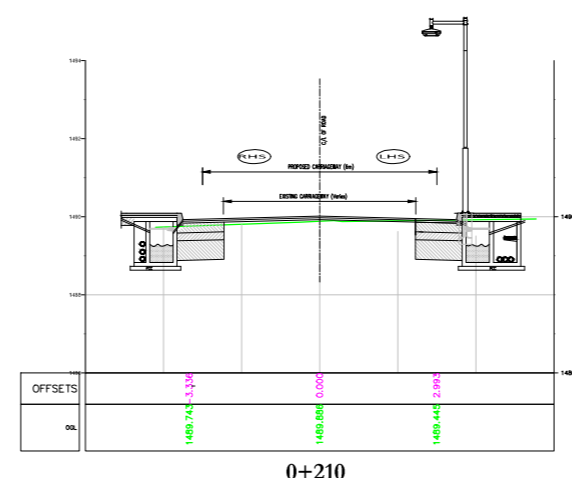
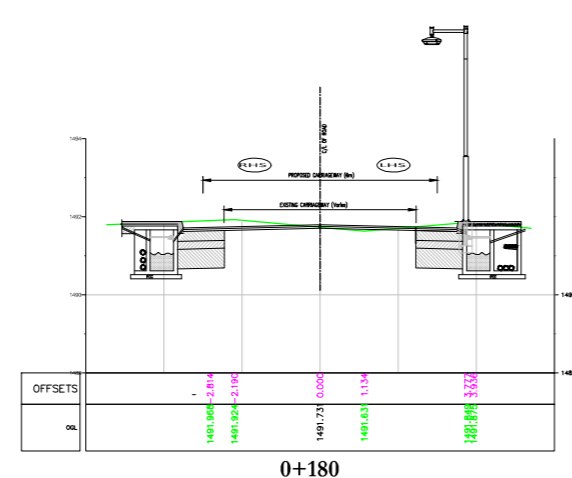
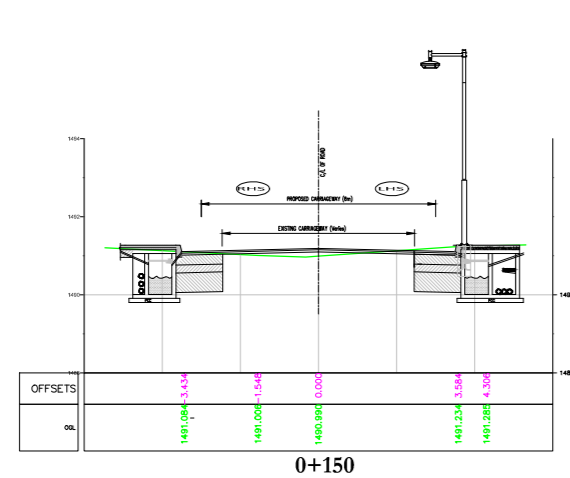
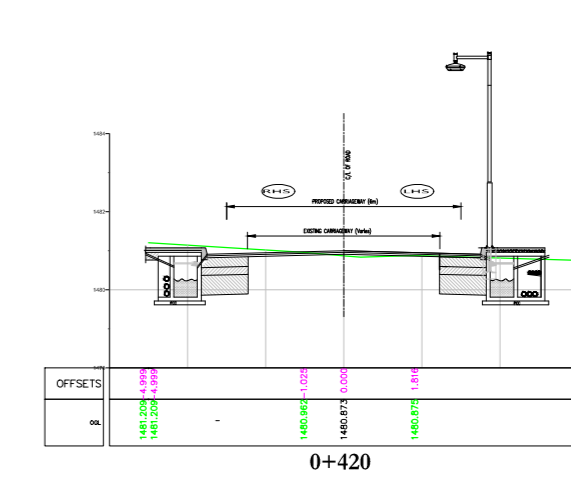
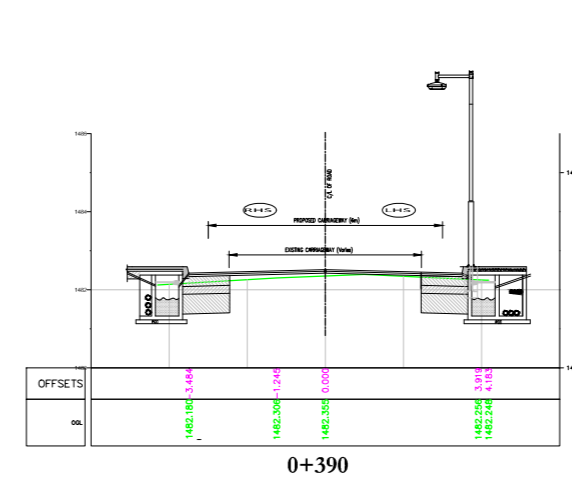
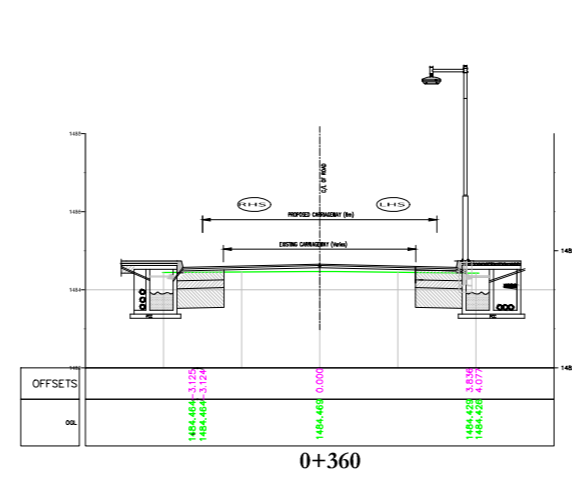
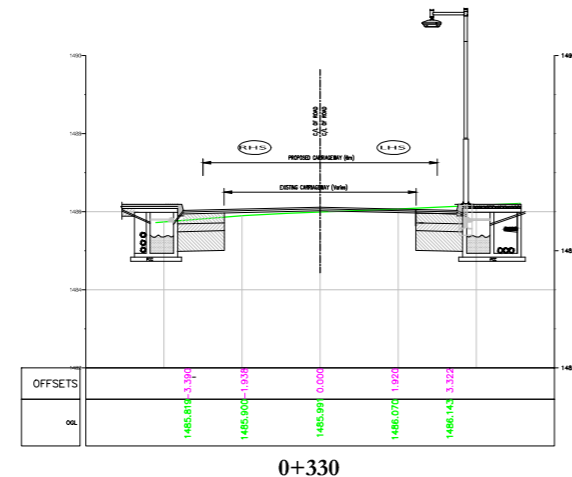
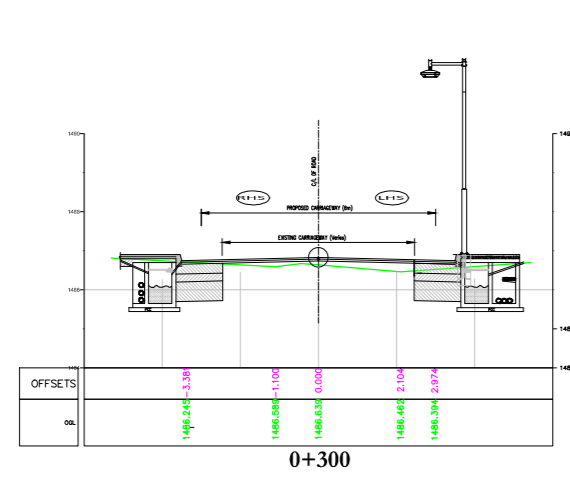
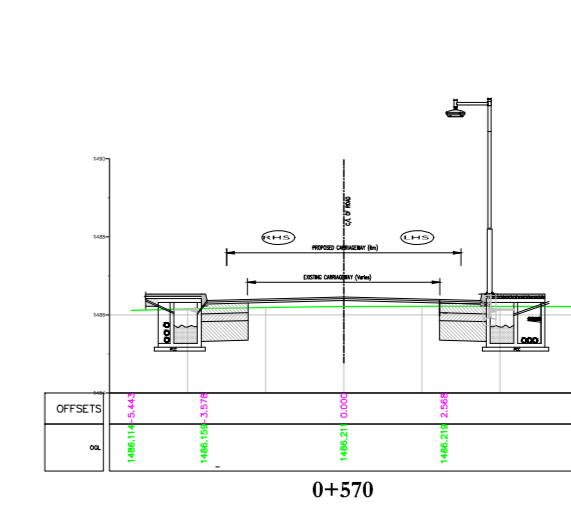
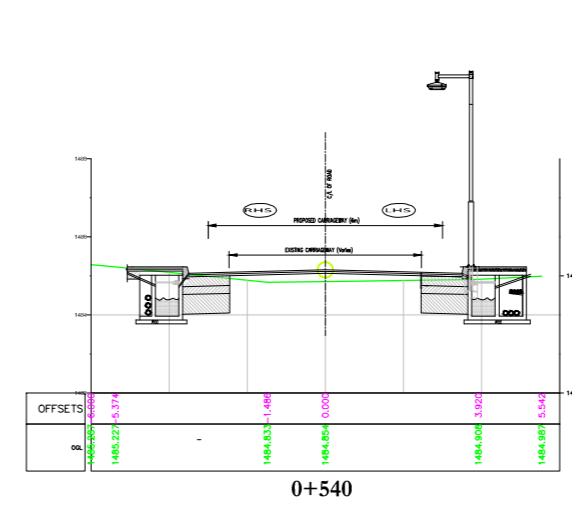
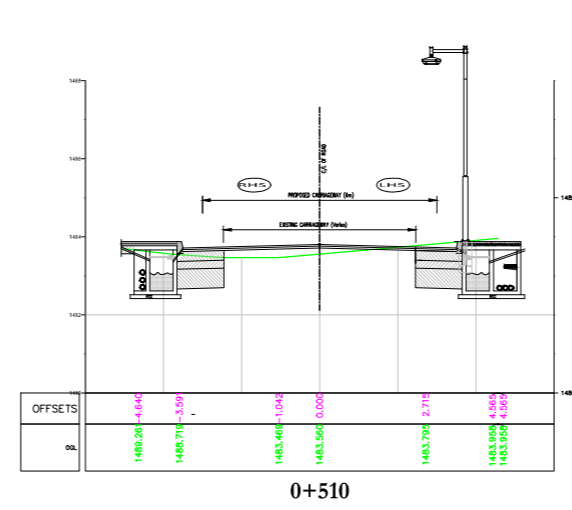
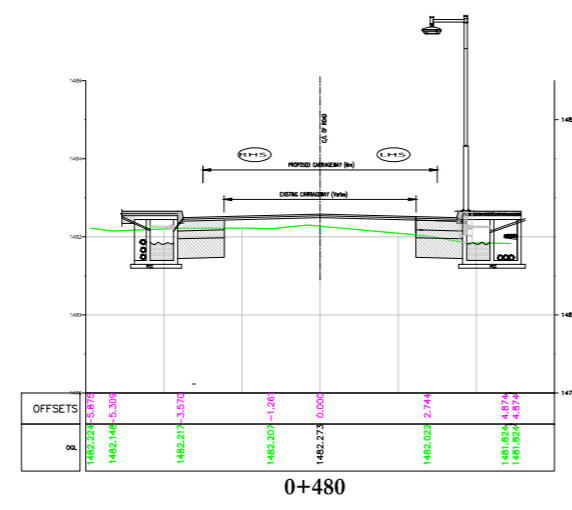
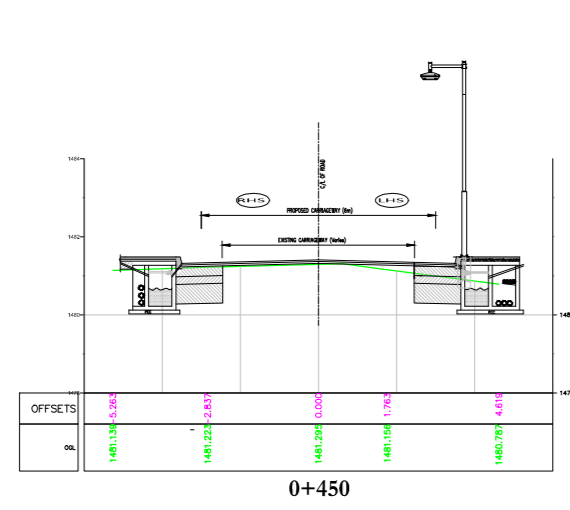
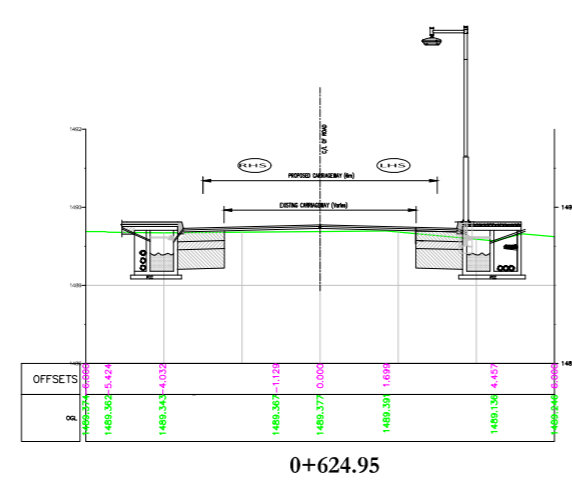
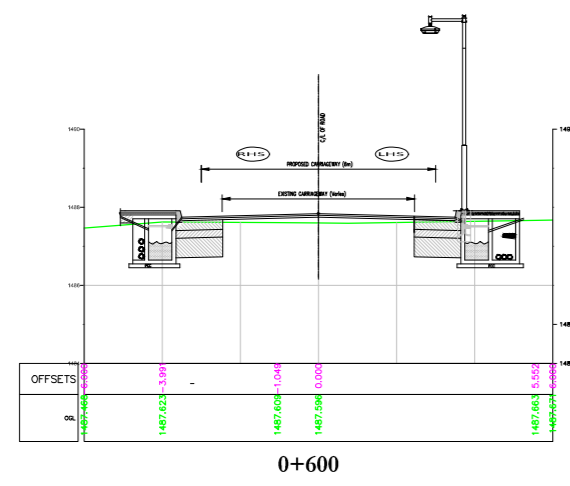

Project:
 DEVELOPMENT OF SMART ROAD IN SHILLONG
 Drg Title:
 (RD-09)
 CROSS SECTIONS
 (From STA : 0+000 to STA : 0+648.30)

Drg No : RD-9/CS-09
 Scale : NTS
 Date : 07.03.2019
 Contract No. :
 Rev : R0



DRAWINGS ARE FOR TENDER PURPOSES ONLY

Rev	dd/mm/yyyy	Description	Rev by	dd/mm/yyyy

Designed : IPEG
 Checked : 
 Approved : 

Client
SHILLONG SMART CITY LIMITED

Submitted By
IPEG GLOBAL
 Expanding Horizons. Enriching Lives.

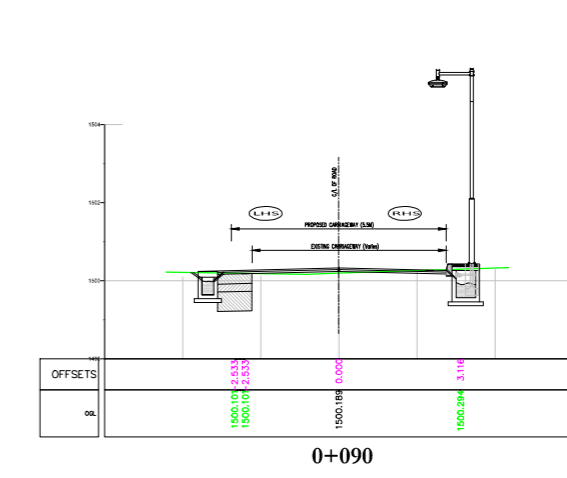
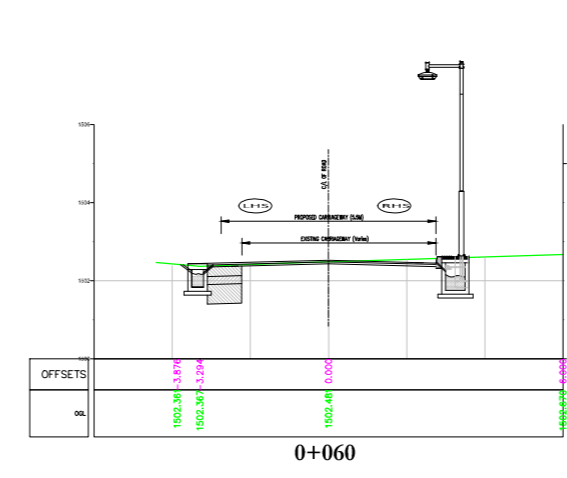
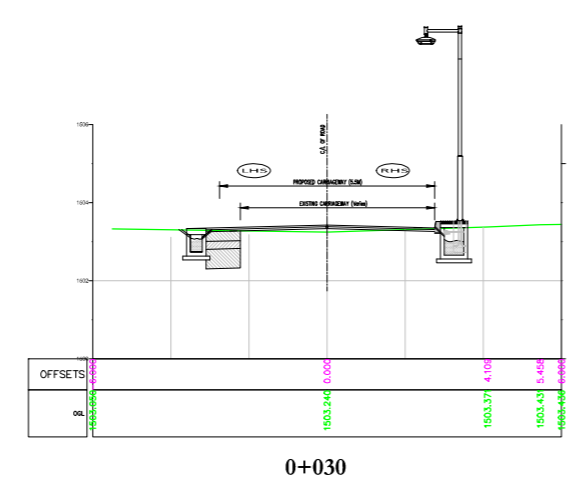
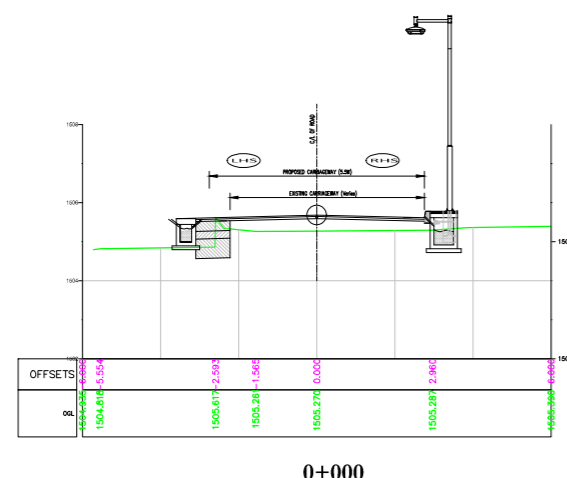
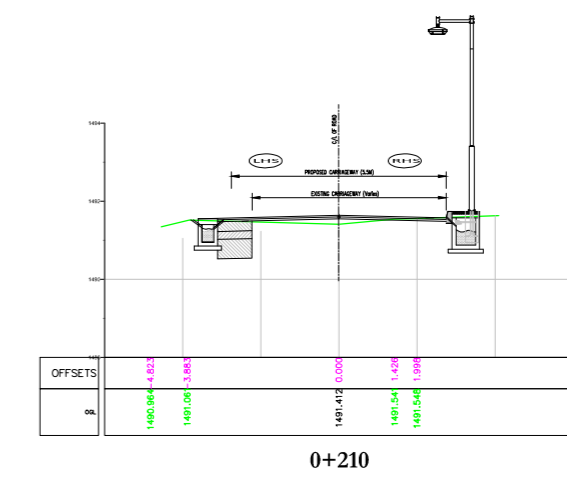
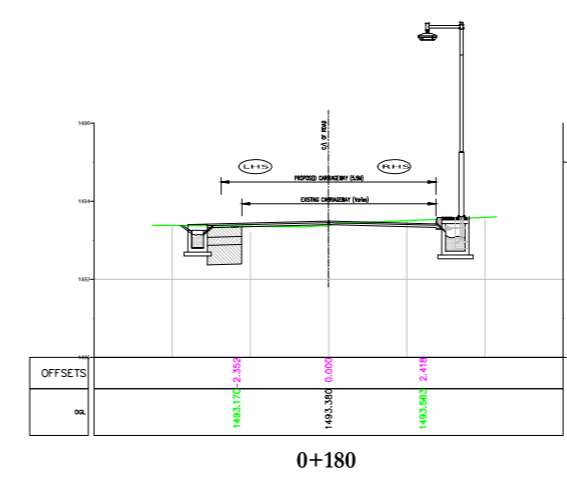
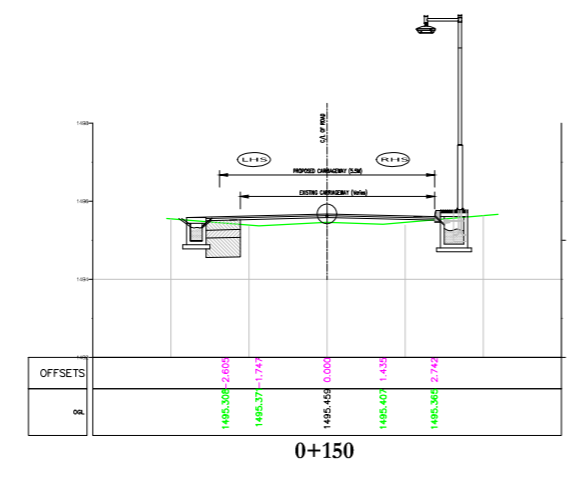
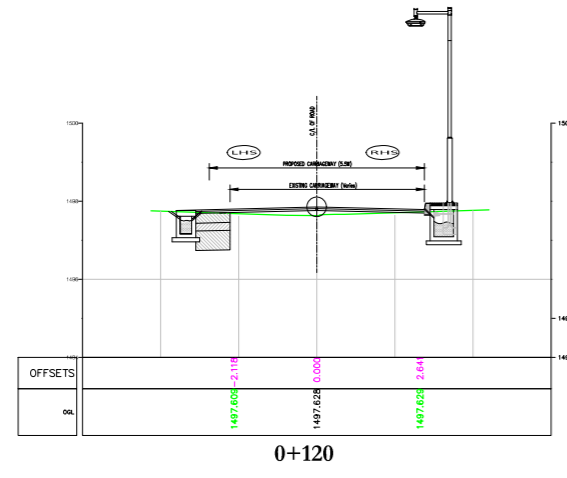
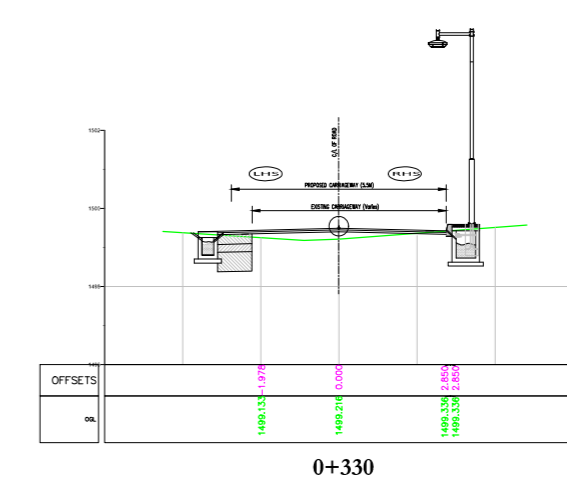
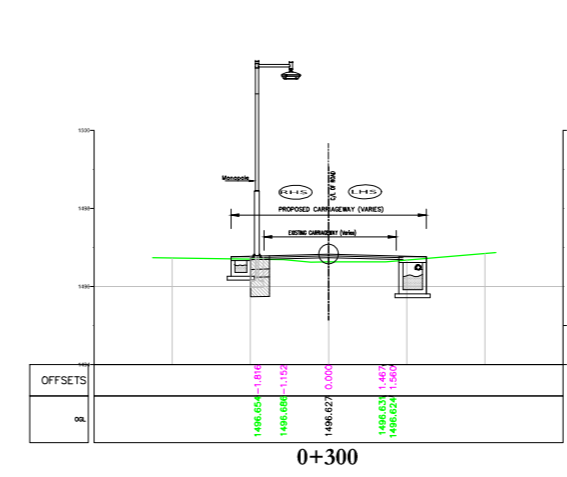
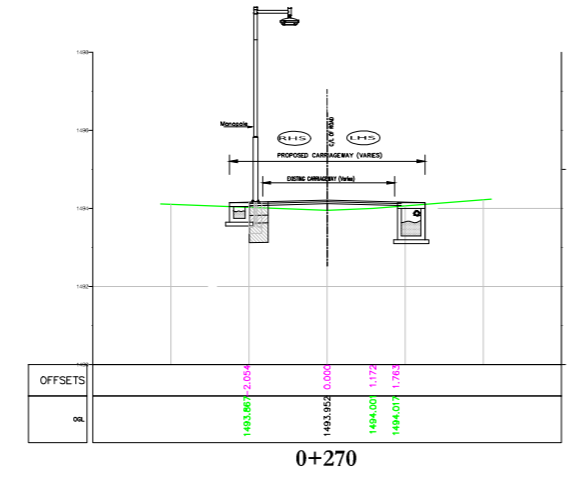
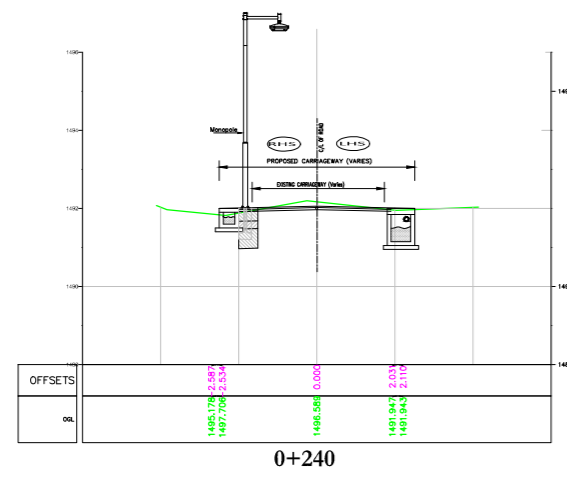
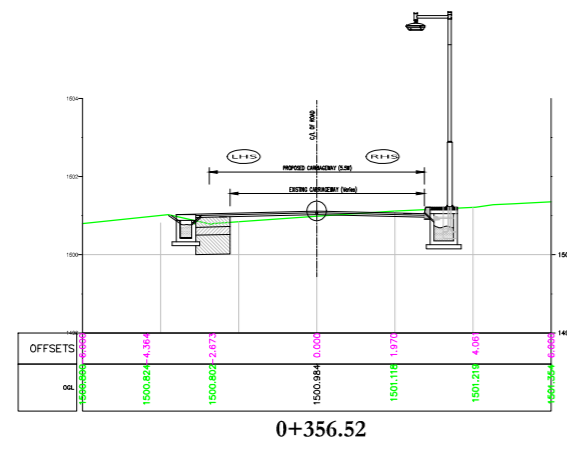

Project:
DEVELOPMENT OF SMART ROAD IN SHILLONG
 Drg Title:
(RD-10) CROSS SECTIONS (From STA : 0+000 to STA : 0+624.95)

Drg No : RD-10/CS-10
 Scale : NTS
 Date : 07.03.2019
 Contract No. :
 Rev R0



DRAWINGS ARE FOR TENDER PURPOSES ONLY

Rev	dd/mm/yyyy	Description	Rev by	dd/mm/yyyy

Designed : IPEG
 Checked : 
 Approved : 

Client
SHILLONG SMART CITY LIMITED

Submitted By
IPEG GLOBAL
 Expanding Horizons. Enriching Lives.

Project:
DEVELOPMENT OF SMART ROAD IN SHILLONG
 Drg Title:
**(RD-11)
 CROSS SECTIONS
 (From STA : 0+000 to STA : 0+356.52)**

Drg No : RD-11/CS-11
 Scale : NTS
 Date : 07.03.2019
 Contract No. :
 Rev R0

